



Ninth and newest edition of a performance champion with an heroic heritage



# CHRYSLER 300-J



There is a kind of man who is prepared to spend a pleasurable premium for a car of extraordinary talents. You won't find this man everywhere. He's as rare as the motorcar he drives. ♣ The Chrysler 300-J is this man's kind of car. For the "J" combines magnificent V-8 power, the comfort and the spaciousness of the American automobile with the agility, the crisp handling and unadorned custom look normally associated with European Gran Turismo machines. ♣ The

"J" is the ninth of a famous series of Chryslers, each of which has been willing to lay its performance reputation on the line and emerge with honor ♣ We don't hurry it along the production line. For that reason, the 300-J will appear in limited numbers only. But if you find excitement in just looking at a car; or adventure in handling a superb automobile, you should get on personal driving terms with the car that brought the term "Grand Touring" back to America.



The 300-J is a car that doesn't understand the word "compromise". The "J" is as much an idea as it is an automobile. This is not to say it's a new idea. There have been a total of eight colorful predecessors in the "J's" background. And in every respect, the "J" is worthy of their distinguished company. The 300-J, in simplest terms, is a high-performance automobile. It is not merely a massive V-8 engine stuffed into a conventional body. Every facet of Chrysler quality engineering has been considered in making the "J" a Grand Touring car respected and admired throughout the world. **The look of the "J" bespeaks its Heritage.** The latest of Chrysler's "beautiful brutes" (a description coined by an automotive magazine writer) reveals a crispness and simplicity of line and a lack of superficial adornment that belongs to quality cars the world over. The grille, the sculptured sweep front to rear, the rake of the windshield suggest the latent power beneath. The "J" is a confident-looking car. Bold but not brassy.

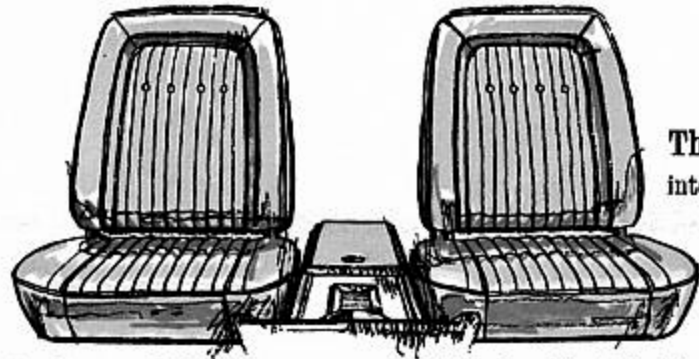

The "J" is considerate of people. The interior of the "J" has been designed to provide maximum comfort for five. The seats are beautifully contoured and separated by a console. When touring in the "J", you are held comfortably in place. Seats

for driver and front passenger are individually adjustable. The silence is most disconcerting to those who associate high-performance with screaming exhausts and the clatter of valve gear. From such silence comes relaxation. Headroom, hiproom, kneeroom (for back seat passengers) considers that Americans, as a rule, are six-foot citizens living in a six-foot world. Result: many owners report that 600 miles is an easy day's work for a "300". In the "J" the driver is the V. I. P. For all its spaciousness and comfort, the 300-J remains a driver's car. The driving position is superb. The steering wheel is ideally placed for long-distance jaunts. The new instrument panel has been designed for information rather than decoration. For example, the speedometer is calibrated to the M.P.H. No guesswork to determine accurate speeds. A tachometer minds the RPM's while a trip odometer measures the miles that flash so easily by. Pushbutton controls for the automatic transmission are located on the control panel. Accomplished drivers are still amazed how clutchless driving can be so responsive in the "J". Now, turn the key! As you do, a magnificent FirePower 413 V-8 bursts into song. The soft growl issuing from the exhausts will be hardly noticeable to the insider. The outsider, though, will look in your direction. For this meticulously engineered power plant is the only production ram-injected V-8 in any American car. Its potential is clearly understood, when the "J" shoulders itself smoothly into traffic. On the highway the ninth edition of the 300 family behaves with an aplomb that does its ancestors proud. Acceleration depends on you, of course. But when your toe goes about the business of moving you away, the carefully engineered FirePower 413 does exactly as bid.

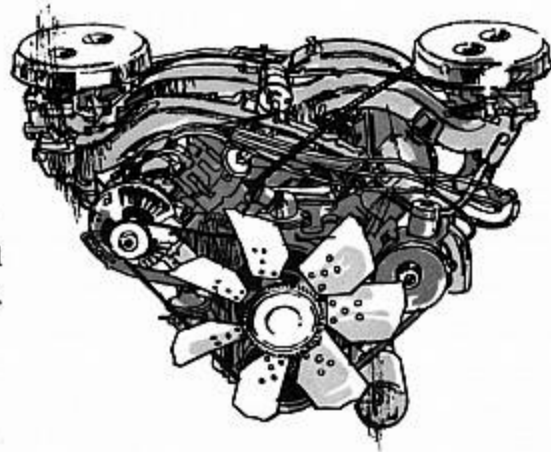

Power surges through long aluminum tube intake manifolds which use outside air to pack a maximum of fuel mixture into the carburetion system. Two, four-barrel carburetors deliver the charge to special high-performance plugs. The "J's" healthy breathing is further aided by two special competition-type air cleaners.

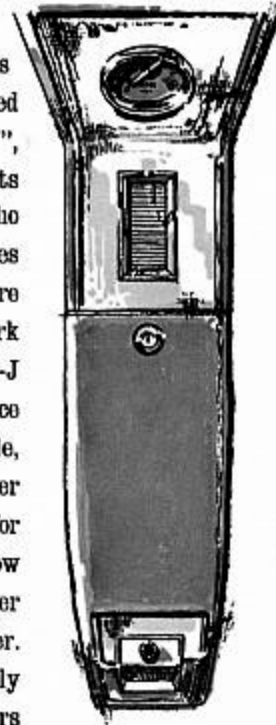

Why does the 300-J handle better than some sports cars? Many consider the "J" to be the finest handling of any 300 built. The superhighways offer little challenge to this superbly balanced automobile. But, ah, those backroads! Here's where the advanced torsion-bar front suspension starts to pay extra dividends. The "J" corners with a precision almost unbelievable for a car of its size. Ask the experts. They've already told us that no full-size car can match a 300 in road behavior. Special sports-racing tires mounted on 15-inch wheels also contribute to the "J's" uncanny adhesion even in wettest weather. **Controllability's the word.** And we mean it. Not only does the 300-J perform with the best

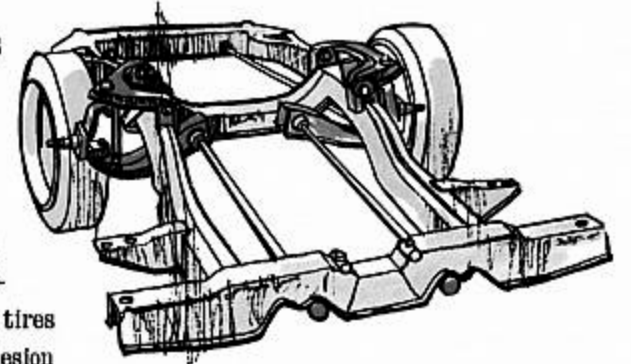

of 'em, outhandle the rest of 'em—it's built to stop, too. Brakes are reassuringly big.

Power assist promotes smooth, sure stopping with minimum pedal pressure. Coupled to its overall handling and ride characteristics, the "J's" brutish brakes handle high average speeds in complete safety. **What more can we say?** Plenty.

The "J's" beautifully engineered body is welded into a solid, rock-like piece.

It's specially dipped seven times in rust- and corrosion-fighting solutions.

Visibility is excellent. In foul weather, special airfoil windshield wipers clear the view ahead. In fact, these new wipers hold snuggler to the windshield at highway speeds.

**Does your Chrysler Dealer's 5-year/50,000-mile warranty\* apply to the 300-J?** It most certainly does. The 300-J's

magnificent power-train (even though we realize 300 owners use their car harder

than most people) is backed by your Chrysler Dealer's extended warranty. Details are

shown below. **Are you the man for the 300-J?** Quite possibly you are. And,

if so, you must be numbered among a select motoring minority. We would like to make this suggestion: see your Chrysler dealer soon and arrange a 300-J test-demonstration. As we have pointed out before, there won't be enough "J's" to go around.

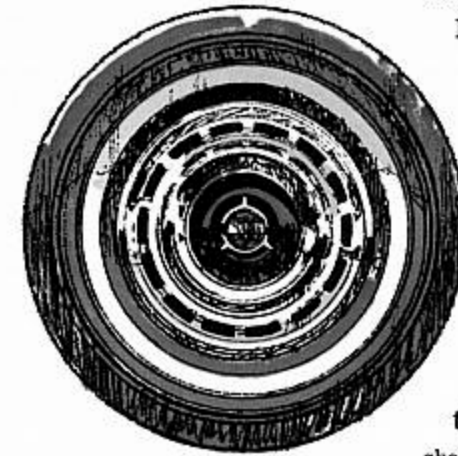

\* New! 5-year/50,000-mile warranty! Your authorized Chrysler Dealer's Warranty against defects in material and workmanship on 1963 cars has been expanded to include parts replacement or repair, without charge for required parts or labor, for 5 years or 50,000 miles, whichever comes first, on the engine block, head and internal parts; transmission case and internal parts (excluding manual clutch); torque converter, drive shaft, universal joints (excluding dust covers), rear axle and differential, and rear wheel bearings, provided the vehicle has been serviced at reasonable intervals according to the Chrysler Certified Car Care schedules.

## The details of greatness: 300-J specifications

**DIMENSIONS:** Wheelbase, 122 in.; front tread, 61.0 in.; rear, 59.7 in.; overall length, 215.5 in. **ENGINE:** FirePower 390, 90° V-8 wedge-type combustion chamber, overhead in-line valve arrangement. High-performance camshaft, heavy-duty valve springs and dampers, special short tube ram induction intake manifolds, mechanical tappets. Bore and stroke—4.18 x 3.75. Piston displacement, 413 cu. in. Compression ratio, 9.6 to 1. Horsepower, 390 @ 4800 rpm. Torque, 485 lb.-ft. @ 3600 rpm. **ELECTRICAL SYSTEM:** 12-volt battery, 78-plate, 70-amp-hr.; 35-amp. alternator (40-amp. with air conditioning). Water resistant ignition. **FUEL & LUBRICATION SYSTEM:** Two 4-barrel down-draft carburetors, mechanically controlled secondary system with auxiliary velocity valves. Manual

choke. Full-flow oil filter. **SUSPENSION:** Special heavy duty torsion bars, sway bar rear leaf springs and shock absorbers. Chassis fittings need no lubrication for 32,000 miles. **EXHAUST:** Large dual exhausts with exhaust headers on the engine. **TRANSMISSION:** TorqueFlite fully automatic torque converter with three-speed planetary gear set, and high speed governor. Pushbutton control on instrument panel. Manual 3-speed with close spaced ratios, performance-type shift linkage is optional. **STEERING:** Constant-Control power steering, standard. Symmetrical idler arm steering linkage. 3½ turns, lock-to-lock. **BRAKES:** 11" x 3" brakes with flared drums in front; self-adjusting; 287.3 sq. in. bonded lining area. Power-assist standard. **BUCKET SEATS:** Individual bucket

seats with separate adjustment for driver and front passenger (4-way power assist for driver), standard. Bench seat, rear. **REAR AXLE RATIO:** 3.23 to 1 for breathtaking acceleration. The same rear axle drives all other 300's, too. **POWER WINDOWS:** Can be operated by master control on driver's door panel. Standard. **TRUNK:** Has a trip's-worth of luggage capacity—34 cubic feet in the 300-J hardtop. **TIRES:** 7.60 x 15 Blue Streak, high-performance, nylon super-cushion, tubeless white sidewall, standard. **TACHOMETER:** On center console indicates engine rpm's with high accuracy. Standard. **OTHER FEATURES:** Safety-padded instrument panel. Tilt-type inside rearview mirror. Electric clock. Light package: Backup, glove box and luggage compartment lights. Windshield washers. Factory-applied undercoating

and hood insulation pad. Bumper guards. Directional signals. Chrome stainless steel wheel covers. Dual headlamps. All standard equipment on the 300-J at no extra cost. **OPTIONAL EQUIPMENT:** Pushbutton air conditioner. Pushbutton Golden Tone or Golden Touch Tuner radios. Rear shelf speaker. Power antenna. Manual (dealer-installed) or remote control outside rearview mirror. Pushbutton heater. Tinted glass windows and/or windshield. Sure-Grip differential. **EXTERIOR COLORS:** Choice of Black, Oyster White, Alabaster, Madison Grey or Claret. In keeping with Chrysler's continuing program of engineering advancement, all prices, specifications, equipment and colors are subject to change without notice and without obligation to make like changes on cars already produced.

There is another kind of 300, too. The standard 300 series provides the crisp, custom look of Chrysler and outstanding performance at popular prices. The 300 appears in three body styles: 2-door hardtop, 4-door hardtop and sleek convertible. You can choose from a long list of options that enable you to almost custom-build the 300 that appeals most to your taste. Bucket seats offer a sporting motif for the 2-door hardtop and convertible. Performance stems from an exciting choice of two FirePower V-8 engines. And the performance is proved! A team of three 300's competed in the difficult Continental Divide Rally just prior to their public introduction. Result: Official Team Prize (among 15 foreign and domestic teams) and individual placings of second, fourth and ninth in the Rally competition! ¶ Why not drive the car that's built for driving. See if the 300 isn't one of the great full-size values of the year. Your Chrysler dealer will gladly arrange a demonstration.

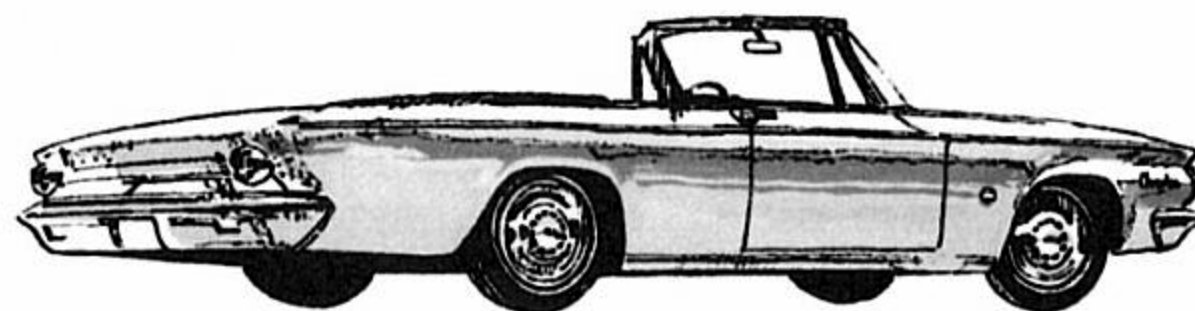
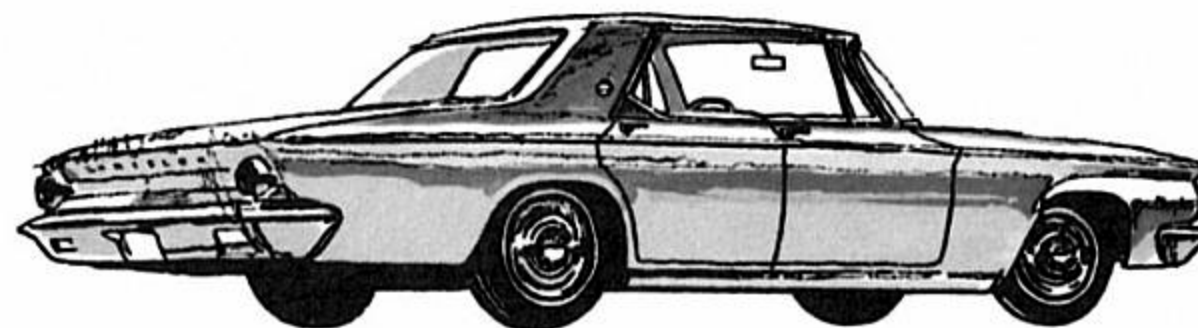
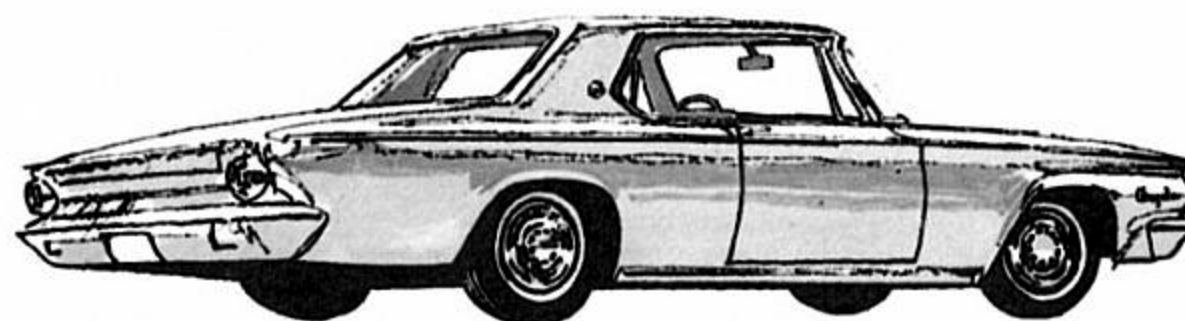

CHRYSLER DIVISION



CHRYSLER  
MOTORS CORPORATION